

240 VOLT 1Ø 85 AMPS

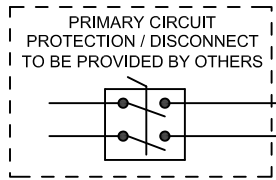

L1  
L2

RELAY 1  
8 KW MAX

RELAY 2  
8 KW MAX

LOW VOLTAGE CONTROL INPUT

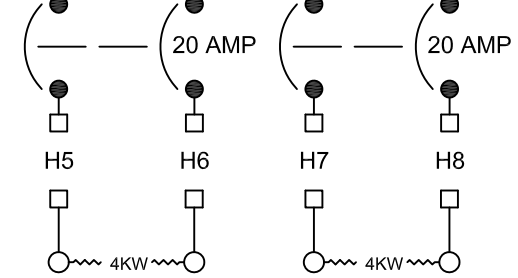
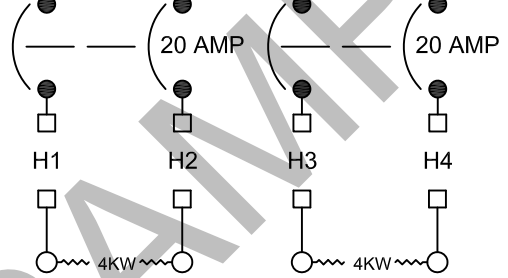
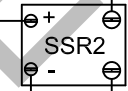
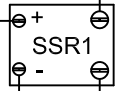
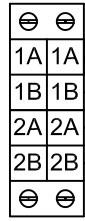

<b>INFRA TECH</b> <small>www.infratech-usa.com</small>		<small>15700 S. Figueroa St.          Gardena, California 90248          Phone: (310) 354-1250          Fax: (310) 523-3674</small>	
		DESCRIPTION 2 RELAY CONTROL PANEL 240 VOLT SINGLE PHASE 85 AMPS	
CUSTOMER Sample			
DATE		ITEM# 30-4052	
		JOB#	UL#

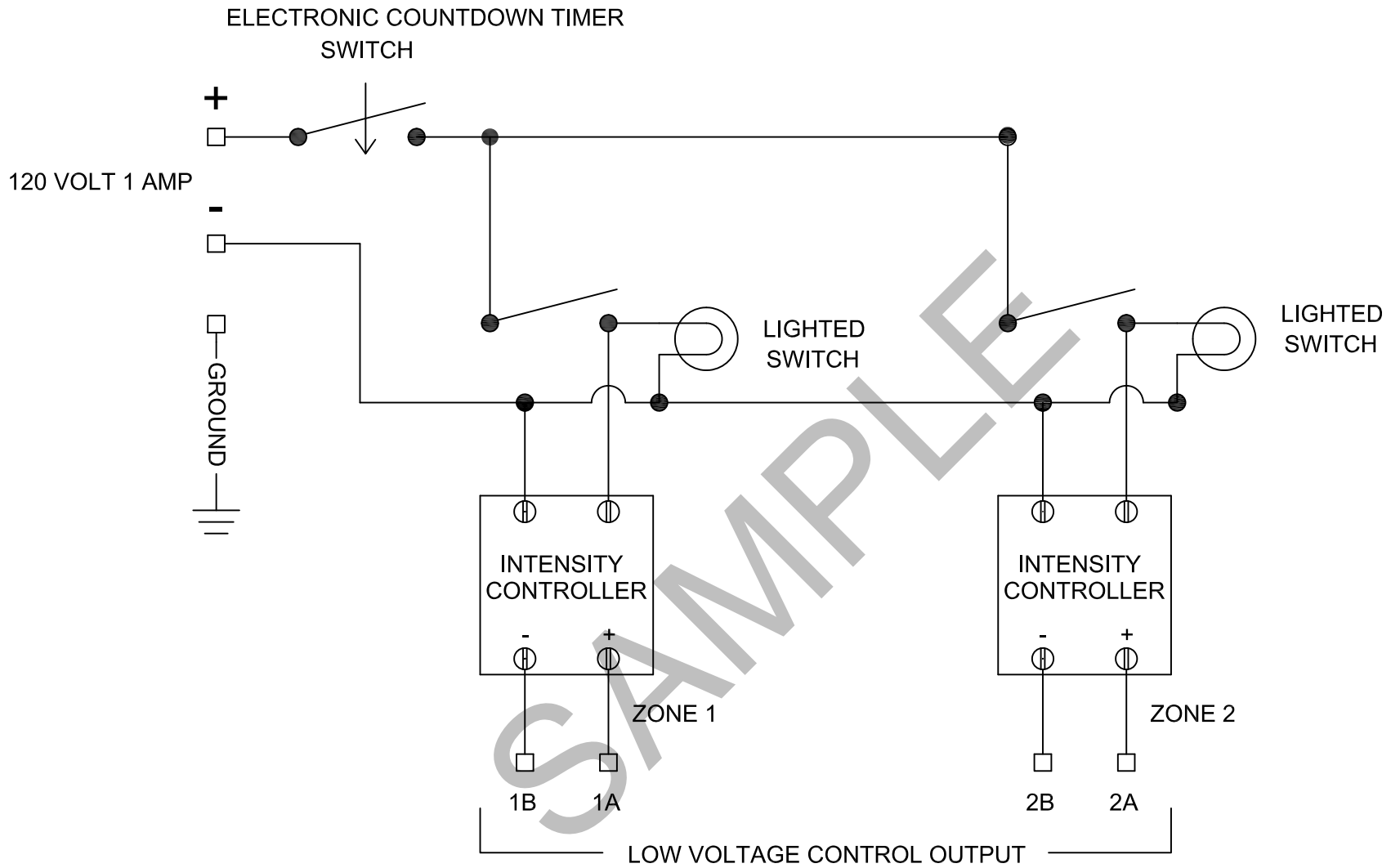

NOTE: USE TWISTED PAIR OR SHIELDED WIRE FOR LOW VOLTAGE HOOK-UP.

<b>INFRATECH</b> <small>www.infratech-usa.com</small>		<small>15700 S. Figueroa St.        Gardena, California 90248        Phone: (310) 354-1250        Fax: (310) 523-3674</small>	
		DESCRIPTION 2 ZONE REMOTE INTENSITY CONTROL UNIT WITH INTERMATIC ELECTRONIC IN-WALL TIMER (15-30-60-120-240 MIN.)	
CUSTOMER		Sample	
DATE	ITEM#	30-4046	
	JOB#		